

TRANSFER LINES



HELIUM TRANSFER LINES:

- » *Flexible*
- » *Rigid (one piece)*
- » *Rigid Bayonet*



NITROGEN TRANSFER LINES:

- » *Vacuum Insulated*
or
- » *Foam Insulated*
- » *Rigid*
- » *Flexible*

CRYO

Liquid Helium Transfer Lines

Cryo Industries offers many versions of the Liquid Helium Transfer Lines. The two most common Liquid Helium Transfer Lines are:

Compact Flexible Liquid Helium Transfer Line

Per customers' requests, we are manufacturing a compact version of the standard liquid helium transfer line. A rugged, yet, very easy to handle performance by design system. Dimensions optimized for use by one person.

The model HTL-438A-B2 features high efficiency, convenient double right angle design, flexible stainless steel vacuum jacket, bellows type evacuation valve, safety pressure relief and a pair of 12" long removable tips.

Storage dewar (upstream) leg length	48" (1219 mm)
Cryostat leg (downstream) length	30" (762 mm)
Flex Length	45" (1143 mm)
Delivery	Immediate-From Stock

Safe and Reliable - CRYO transfer lines have safety over-pressure reliefs and bellows type vacuum valves.

Standard Flexible Liquid Helium Transfer Line

The model HTL-438A-B2-M60 features high efficiency, double right angle design, longer flexible stainless steel vacuum jacket, bellows type evacuation valve, safety pressure relief and a pair of 12" long removable extension tips.

Storage dewar (upstream) leg length	48" (1219 mm)
Cryostat leg (downstream) length	30" (762 mm)
Flex Length	60" (1524 mm)
Delivery	Immediate-From Stock

CRYO

Option

Helium level indicator - built into the storage dewar leg - provides continuous readout of liquid helium level remaining in the storage dewar. Digital readout with 'sample and hold' feature.

Vacuum insulation is maintained for the full length of the transfer line leg!
Other systems compromise efficiency in order to fit the level probe.

Liquid Nitrogen Stainless Steel Transfer Lines are available - foam or vacuum insulated

Liquid Helium and Liquid Nitrogen Flexible Transfer Lines can be customized to your exact specifications: long flex lengths, two piece bayonet styles, flow control valves.

Liquid Helium Transfer Lines

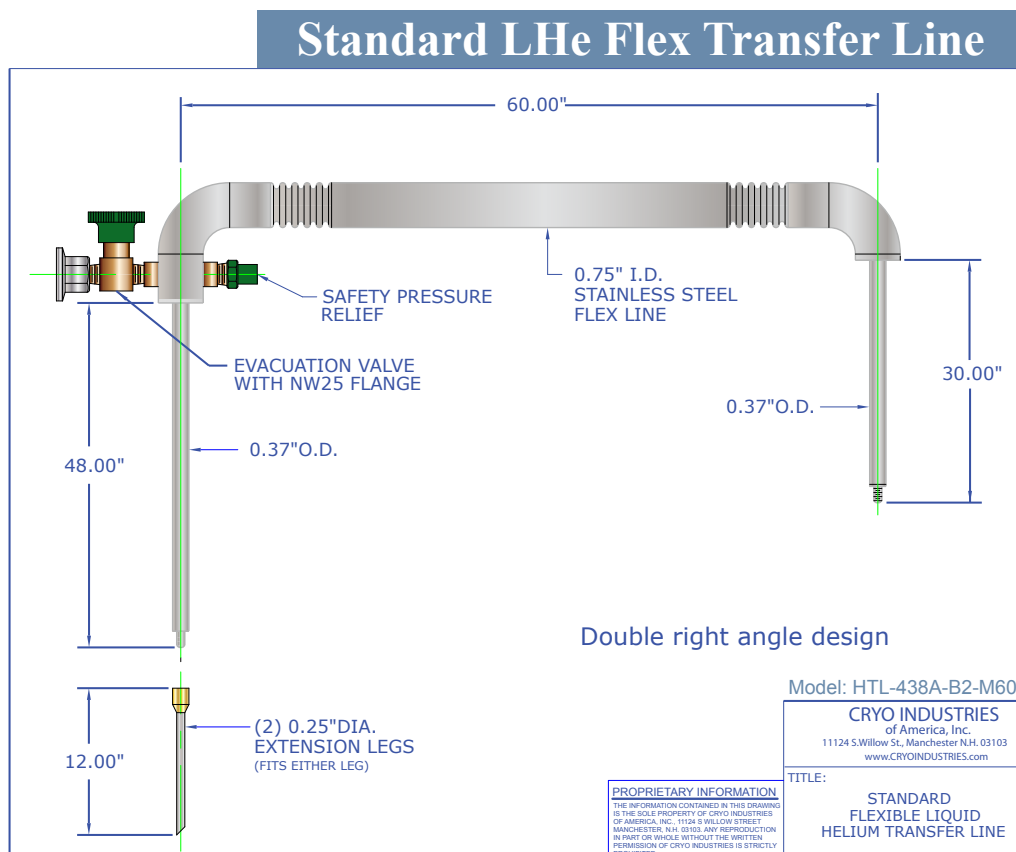

CRYO

Compact LHe Flex Transfer Line

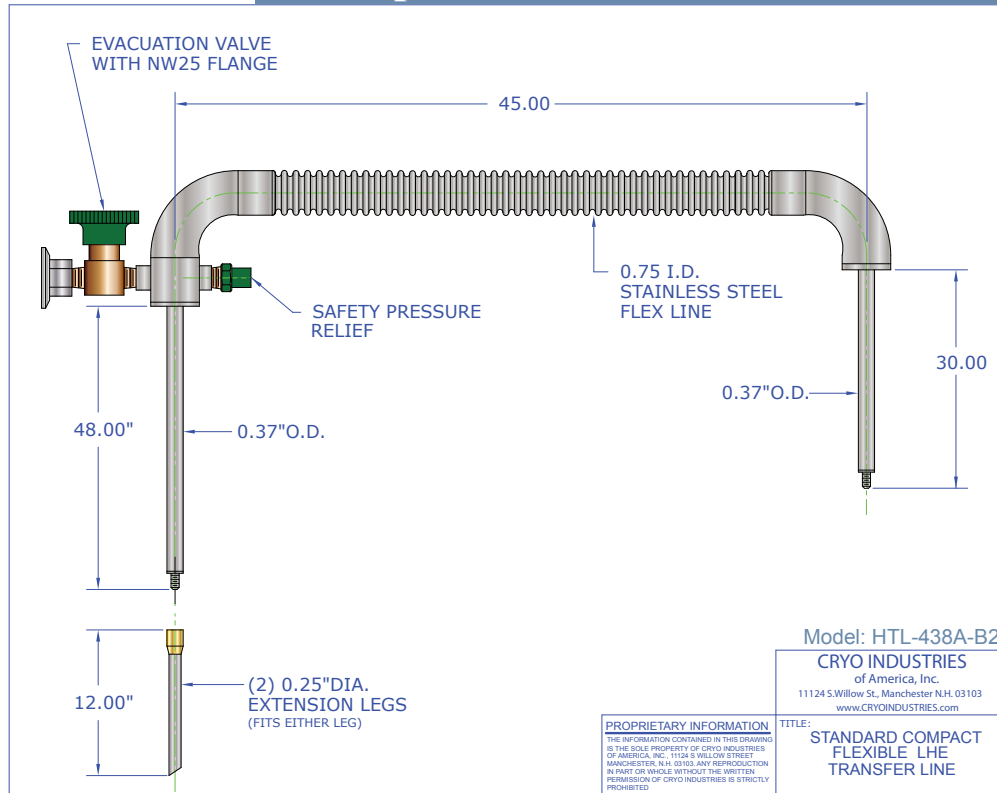

Foam Insulated LN2 Transfer Line

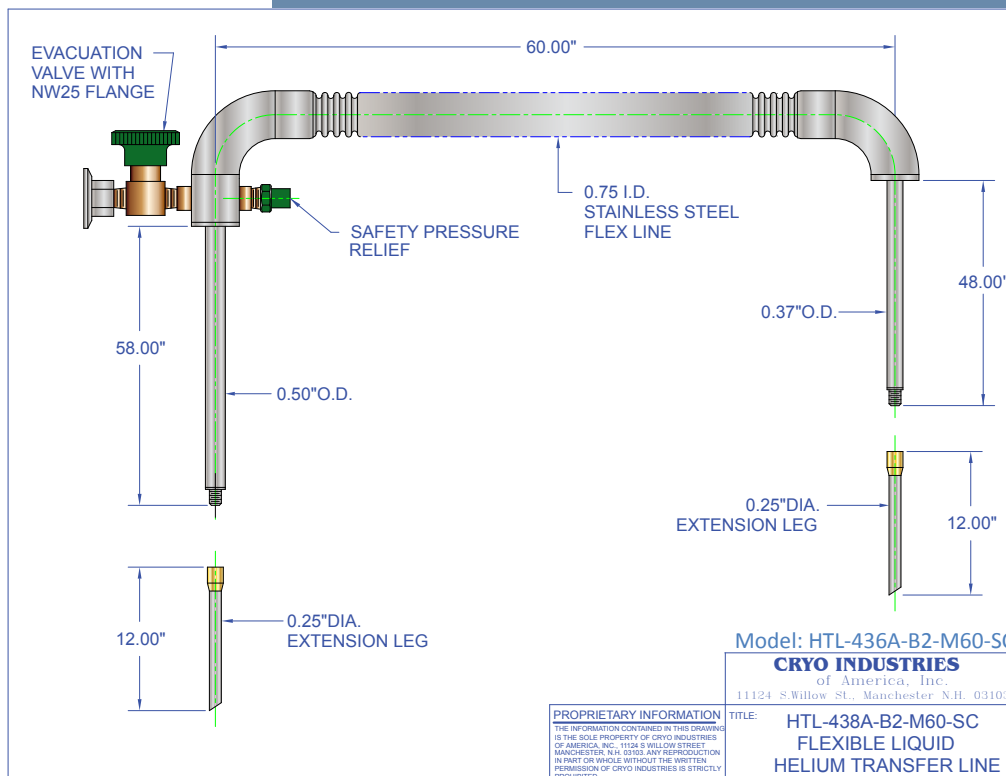

CRYO

Standard LHe Flex Transfer Line

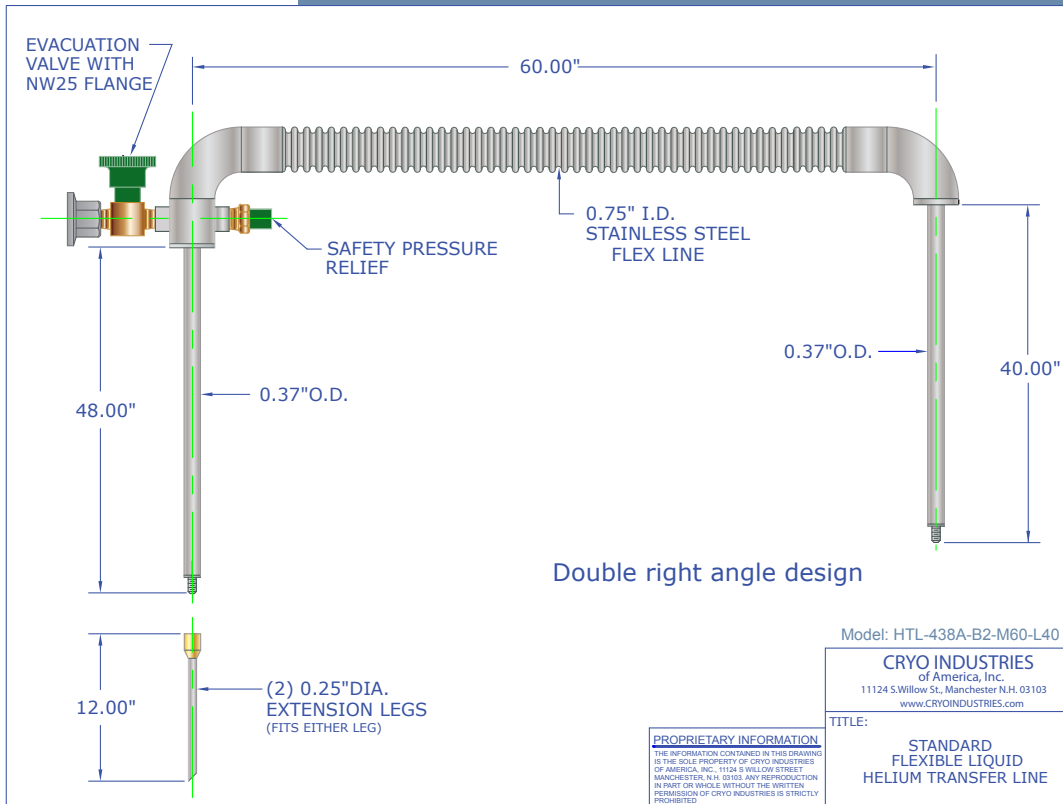

2 Piece LHe Bayonet Transfer Line

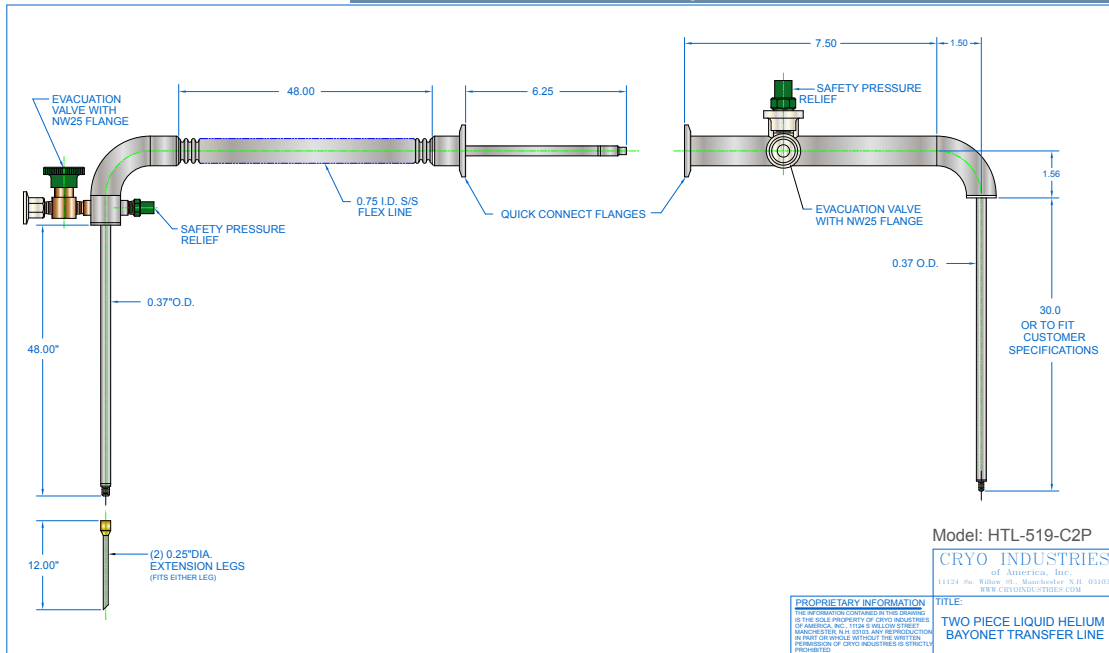

CRYO

Standard RC152 LHe Transfer Line

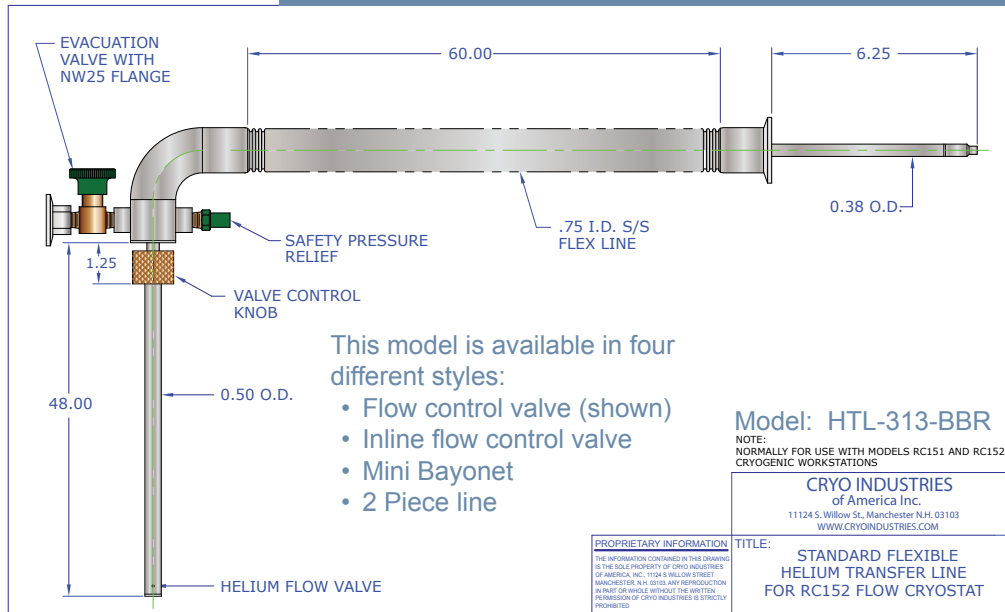

Standard RC102 LHe Transfer Line

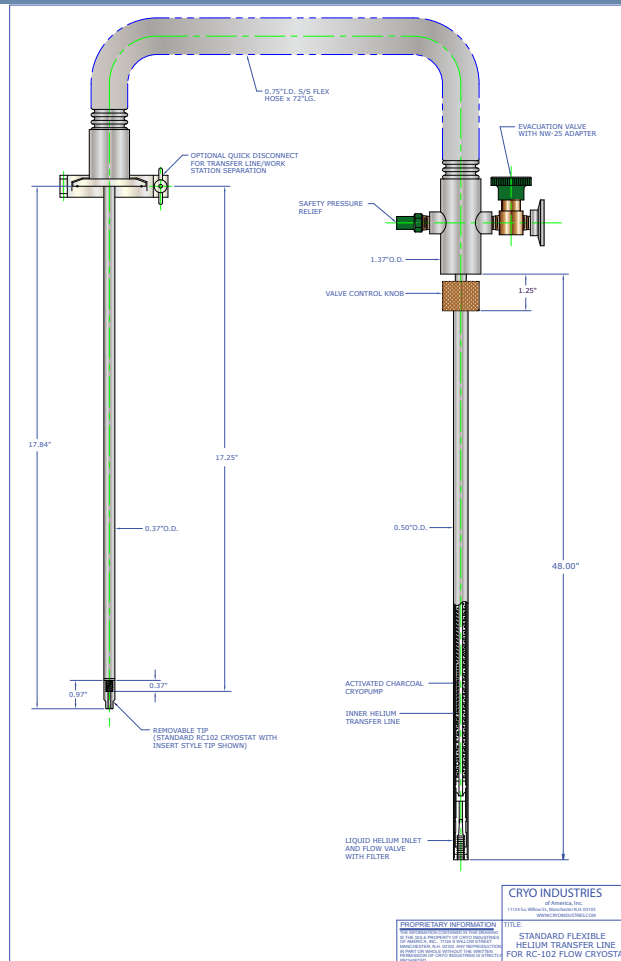

CRYO

Liquid Nitrogen Transfer Lines

Foam Insulated LN² Transfer Line

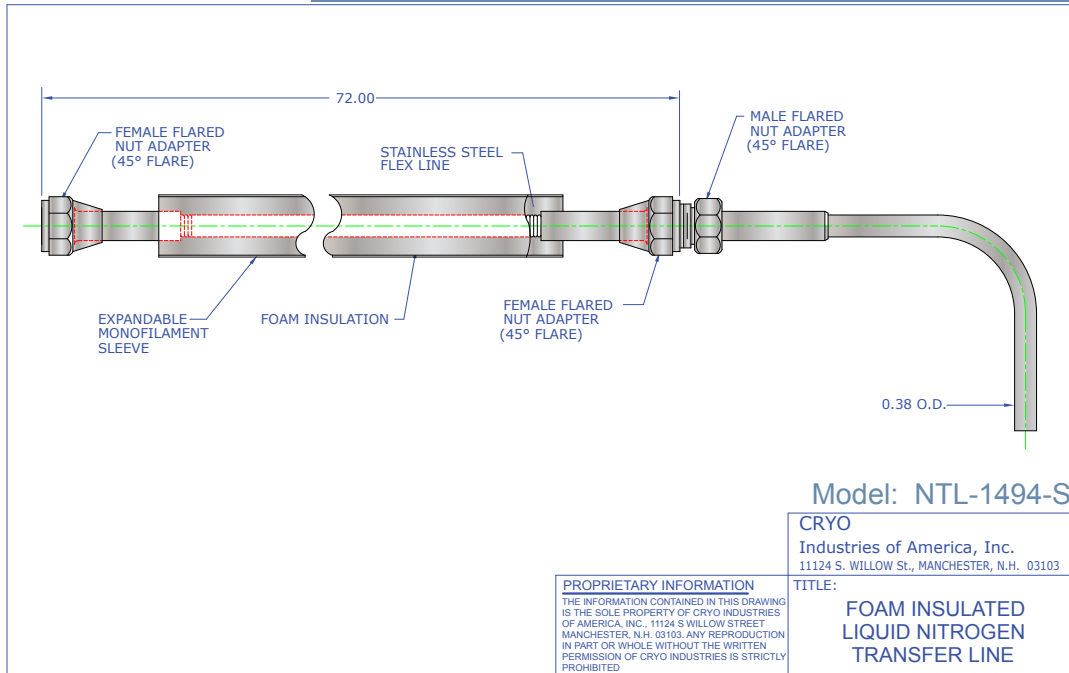

Vacuum Insulated LN² Transfer Line

